

Alphabet Flashcards

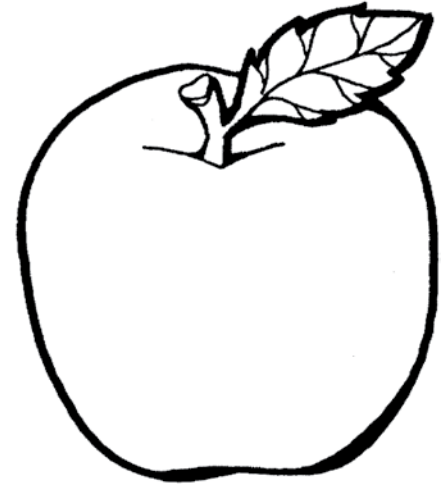

A a



D I



Preview

Please log in to download
the printable version of this worksheet.

C c

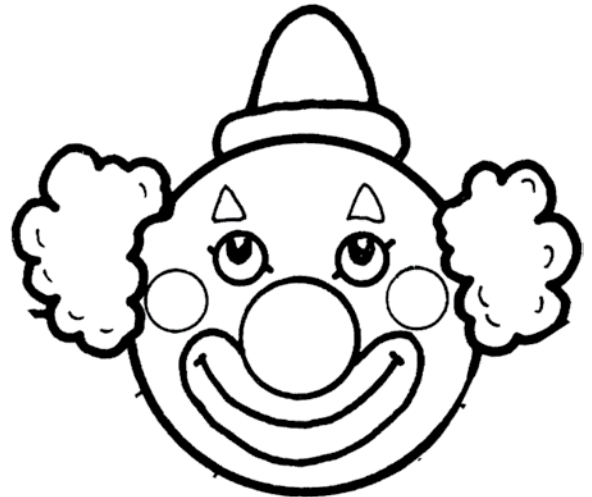



D d

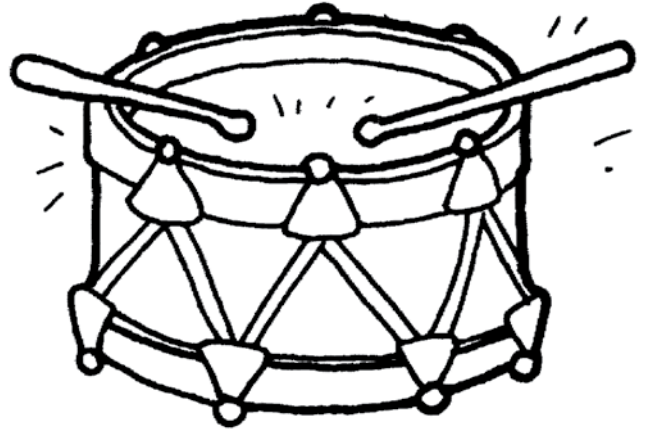

Preview

Please log in to download
the printable version of this worksheet.

F f

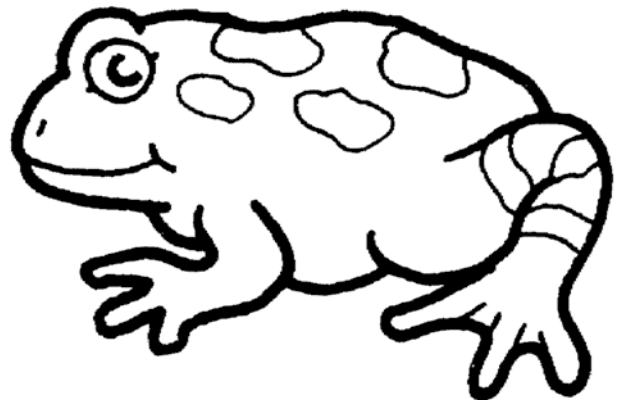



Gg



Preview

Please log in to download
the printable version of this worksheet.

Ii

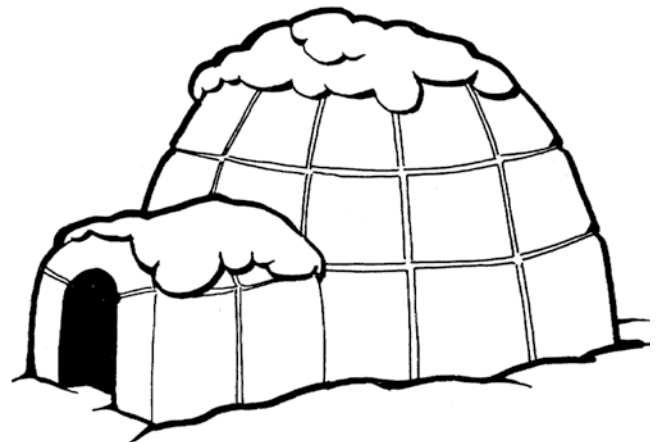



J j

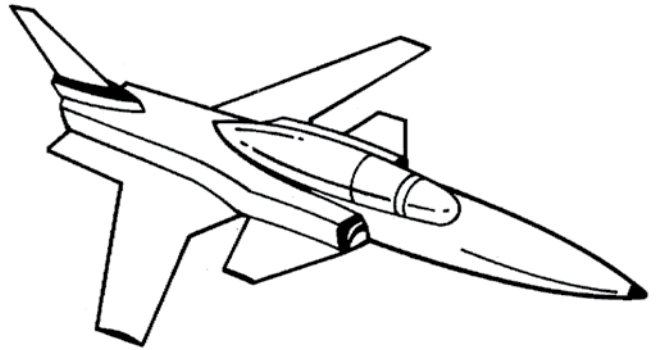

Preview

Please log in to download the printable version of this worksheet.

L l

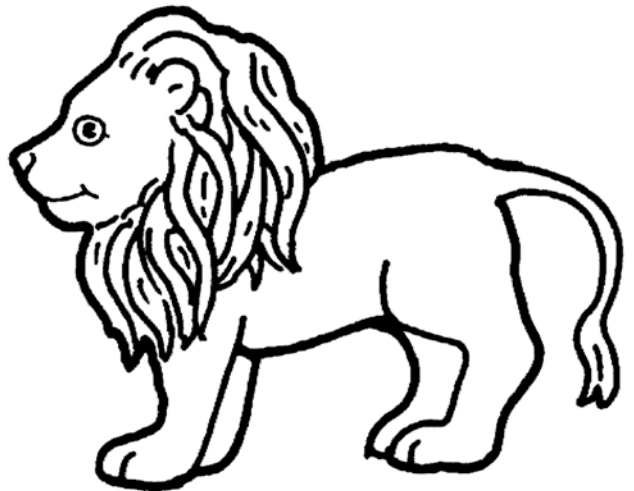



Mm

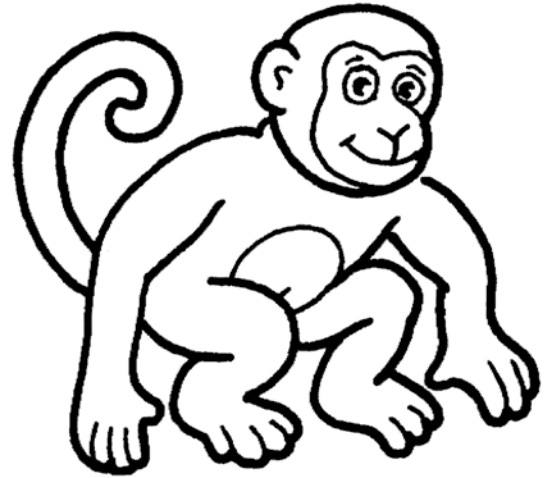

Preview

Please log in to download the printable version of this worksheet.

Oo

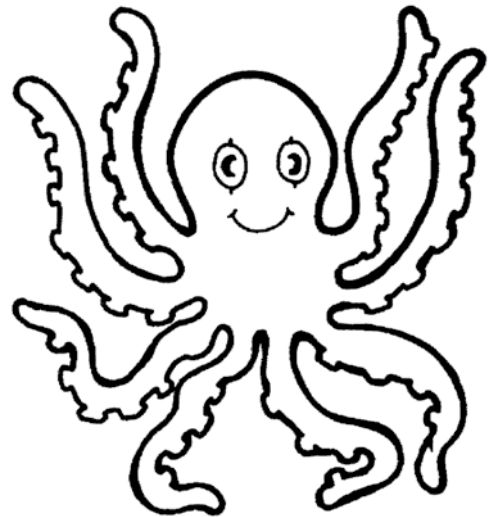

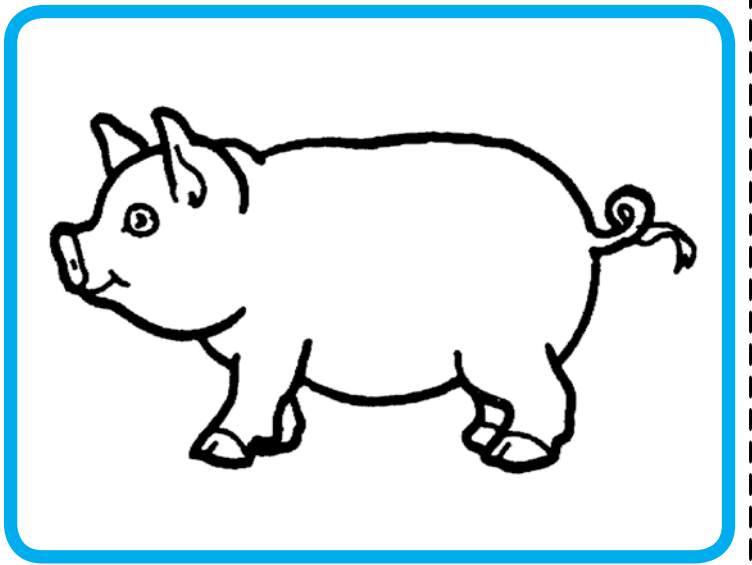
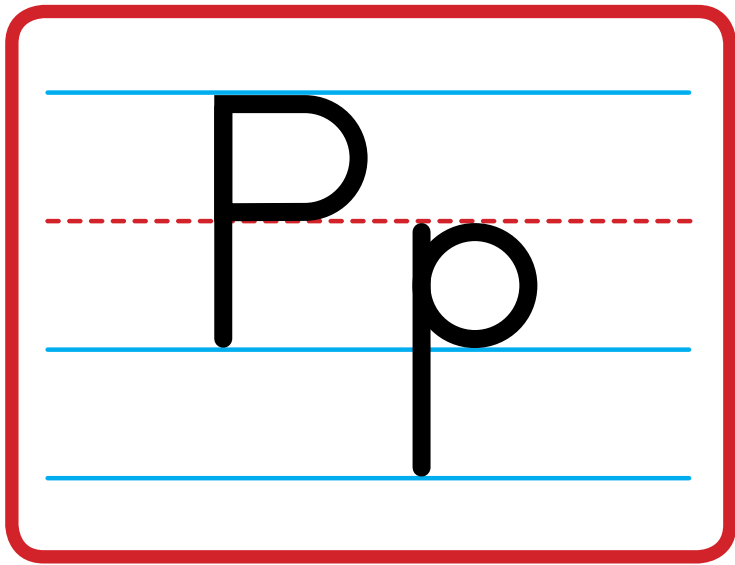

Preview

Please log in to download the printable version of this worksheet.

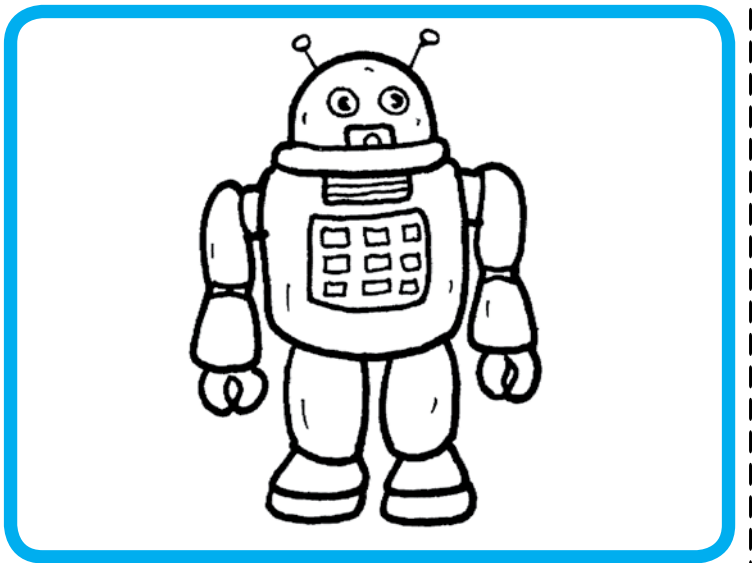
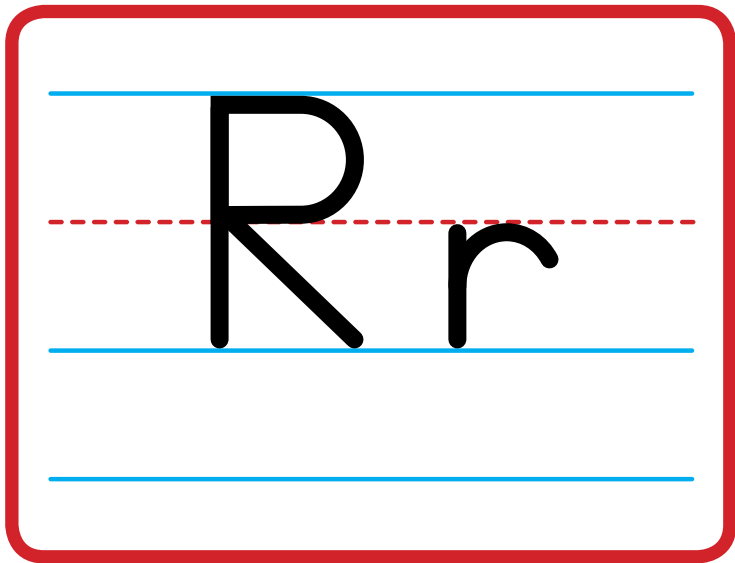



S s

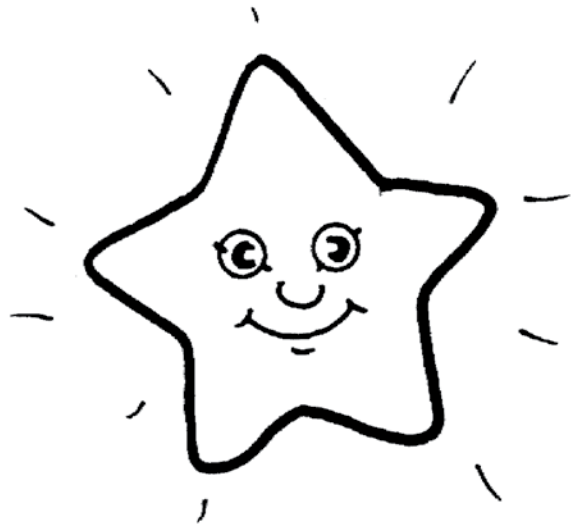

Preview

Please log in to download the printable version of this worksheet.

U u





V v

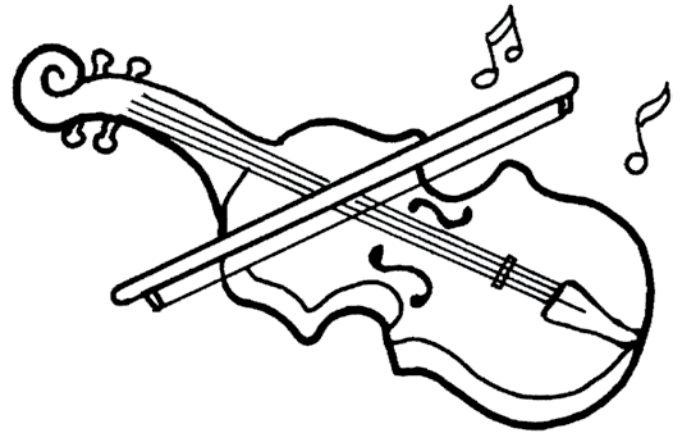

Preview

Please log in to download the printable version of this worksheet.

X x

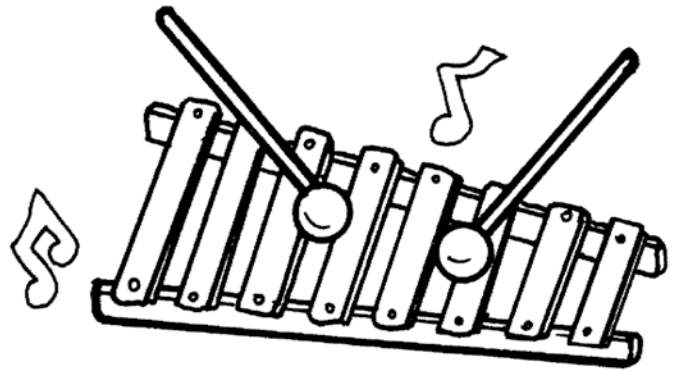



Y y

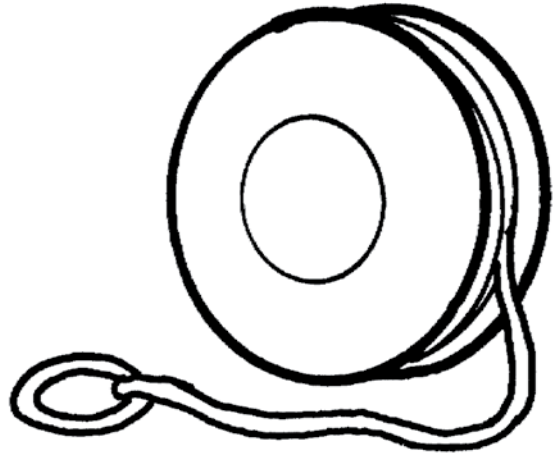

Preview

Please log in to download
the printable version of this worksheet.