

Name: _____

Combining Angles

Find the measure of the angles.

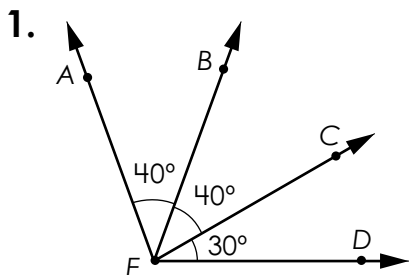

What is the measure of $\angle AEC$?

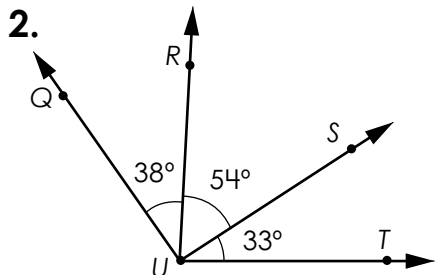

What is the measure of $\angle RUT$?

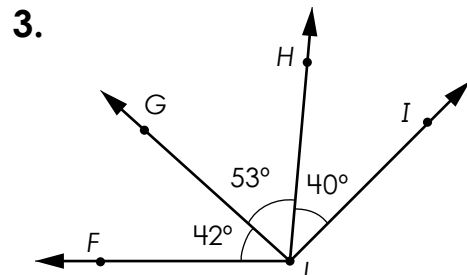

What is the measure of $\angle FJI$?

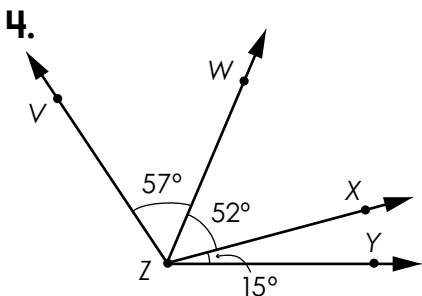

What is the measure of $\angle WZY$?

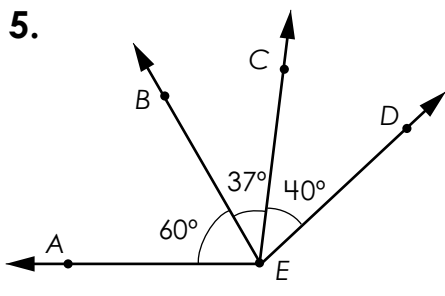

What is the measure of $\angle AED$?

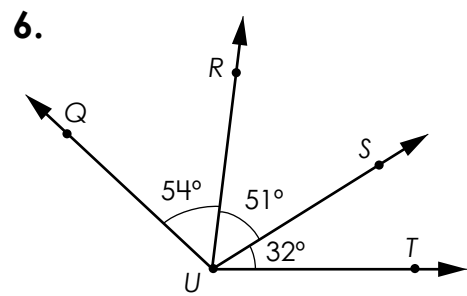

What is the measure of $\angle QUS$?

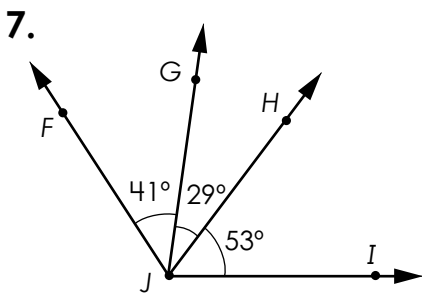

What is the measure of $\angle FJH$?

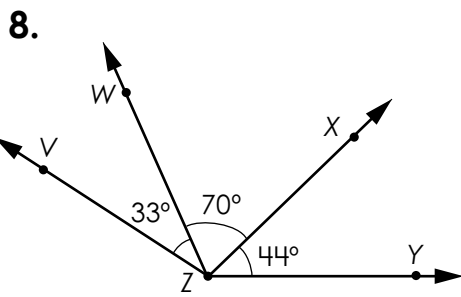

What is the measure of $\angle VZY$?

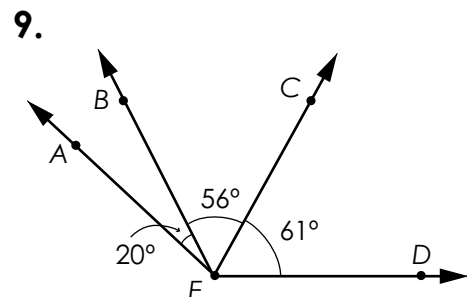

What is the measure of $\angle BED$?

ANSWER KEY

Combining Angles

Find the measure of the angles.

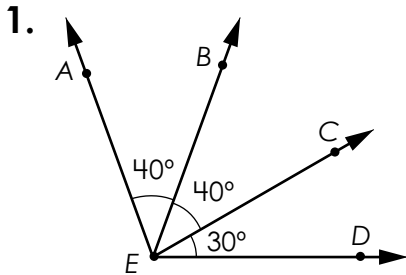

What is the measure of $\angle AEC$?

80°

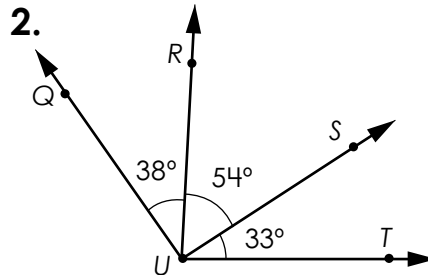

What is the measure of $\angle RUT$?

87°

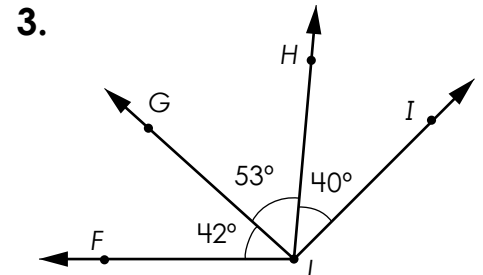

What is the measure of $\angle FJI$?

135°

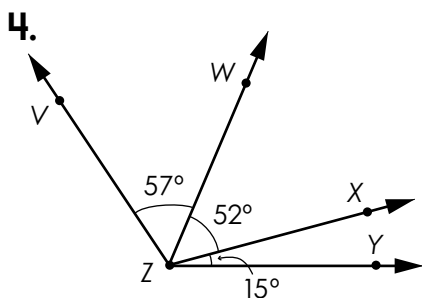

What is the measure of $\angle WZY$?

67°

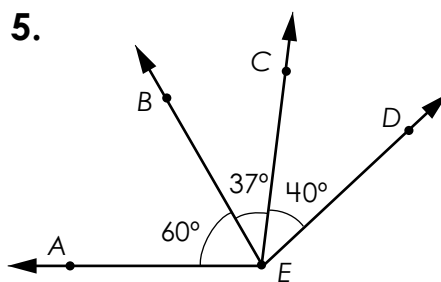

What is the measure of $\angle AED$?

137°

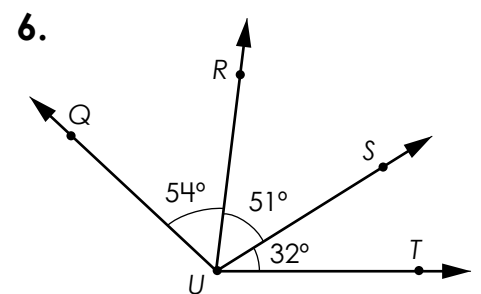

What is the measure of $\angle QUS$?

105°

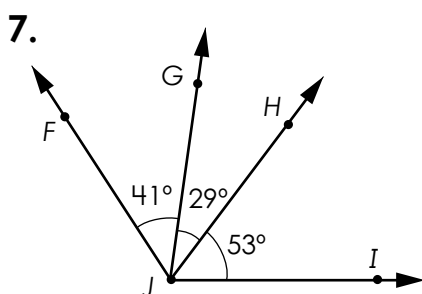

What is the measure of $\angle FJH$?

70°

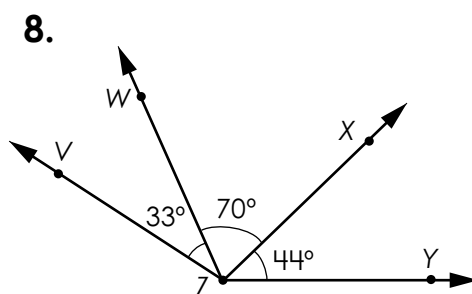

What is the measure of $\angle VZY$?

147°

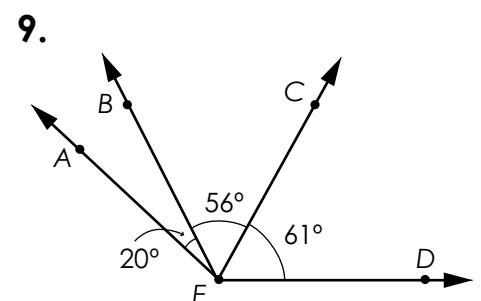

What is the measure of $\angle BED$?

117°