

Name: _____

Translation

Translate $\triangle ABC$ 11 units to the right and 2 units down.
Write the coordinates of $\triangle A'B'C'$.

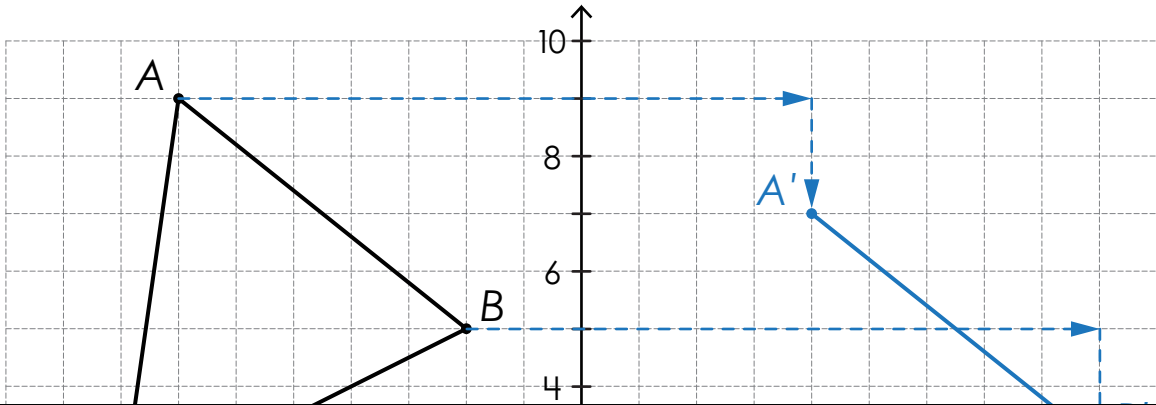

Preview
Please log in to download
the printable version of this worksheet.

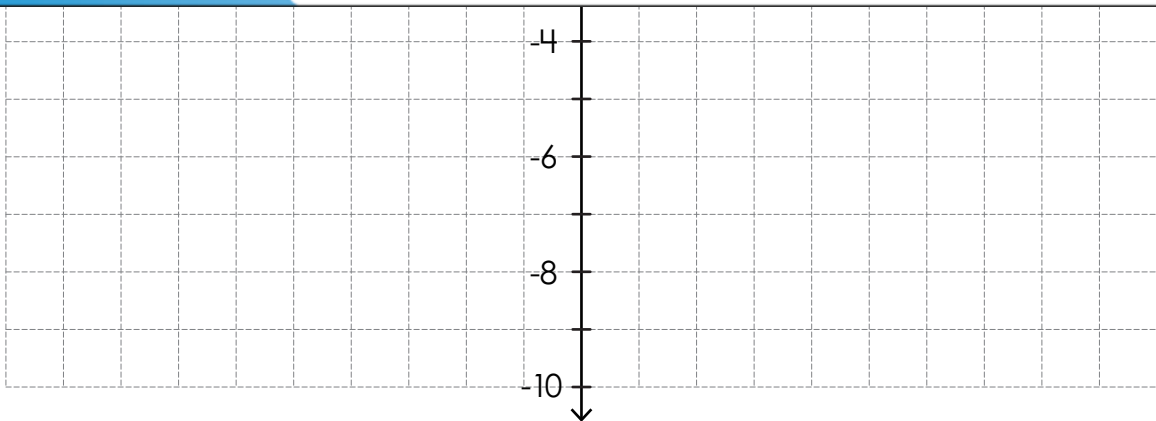

A (-7 , 9)

A' (4 , 7)

B (-2 , 5)

B' (9 , 3)

C (_____ , _____)

C' (_____ , _____)

Name: _____

Translation

Translate $\triangle EFG$ 8 units to the left and 3 units down.
Write the coordinates of $\triangle E'F'G'$.

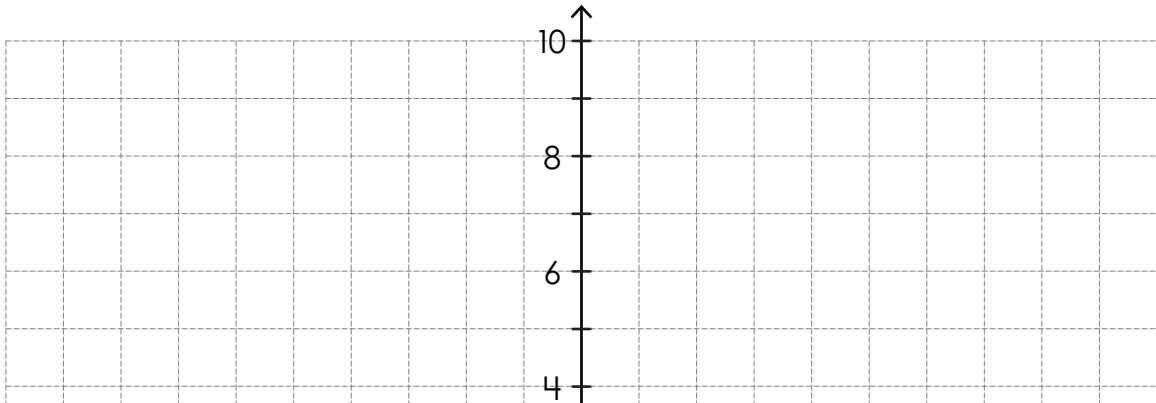

Preview
Please log in to download
the printable version of this worksheet.

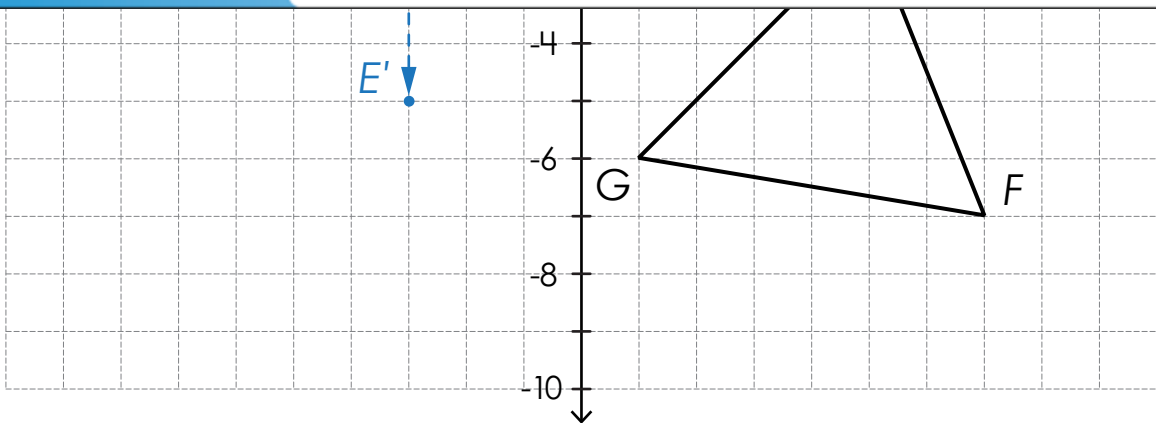

E (5 , -2)

E' (-3 , -5)

F (,)

F' (,)

G (,)

G' (,)

Name: _____

Translation

Translate $\triangle XYZ$ 10 units to the left and 1 unit up.
Write the coordinates of $\triangle X'Y'Z'$.

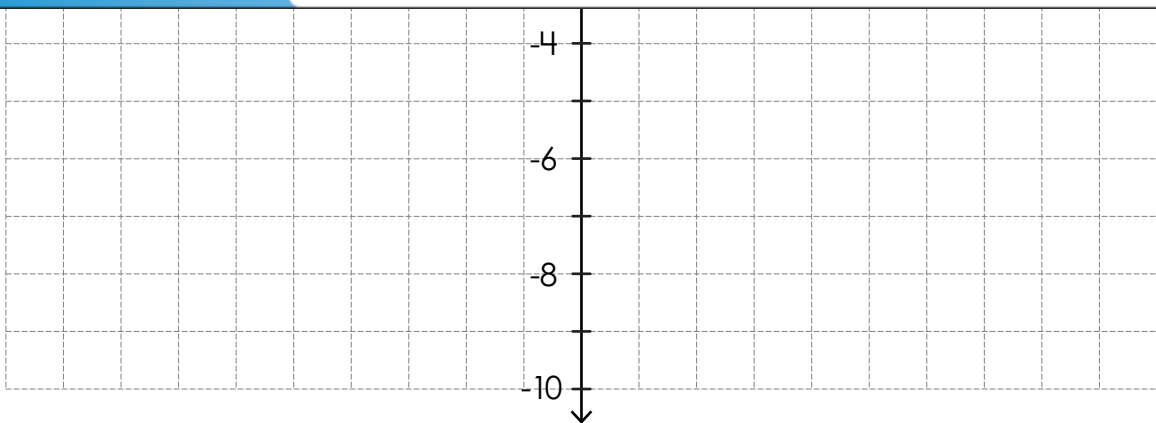
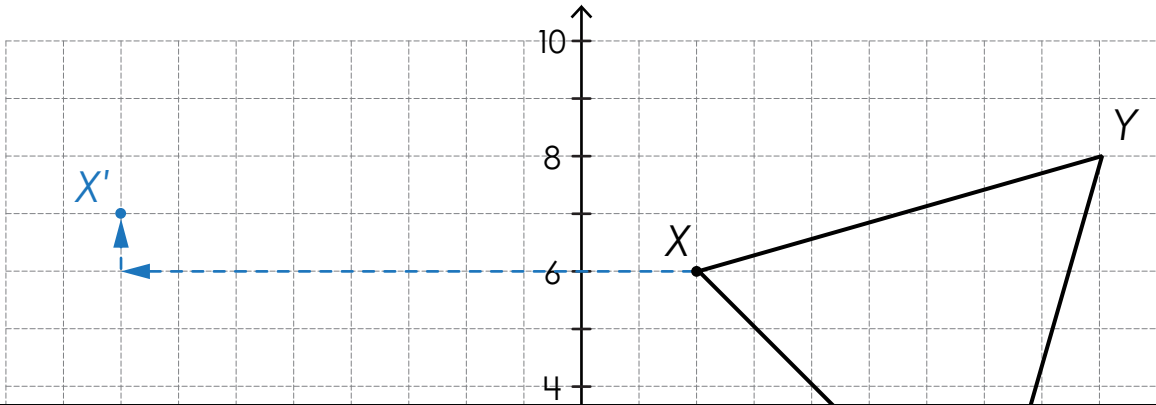

X (2 , 6)

X' (-8 , 7)

Y (_____ , _____)

Y' (_____ , _____)

Z (_____ , _____)

Z' (_____ , _____)

Name: _____

Translation

Translate $\triangle NOP$ 9 units to the right and 9 units up.
Write the coordinates of $\triangle N'O'P'$.

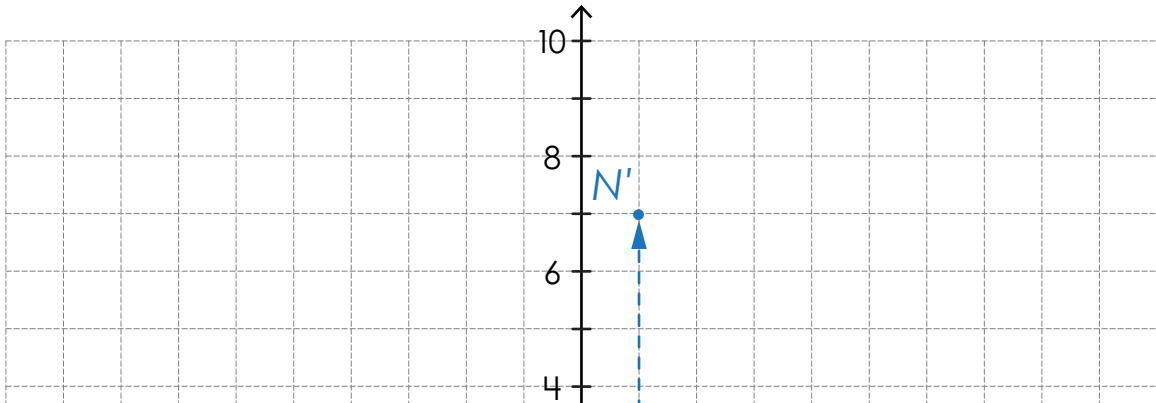

Preview
Please log in to download
the printable version of this worksheet.

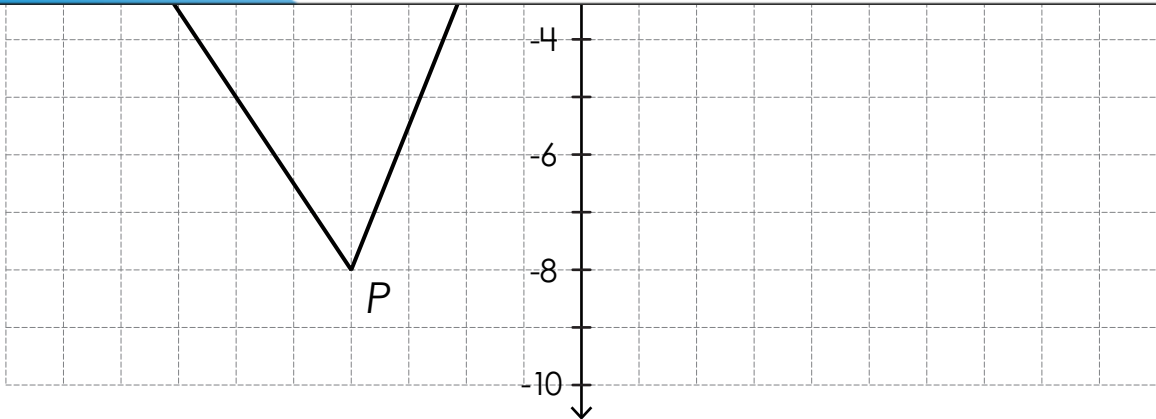

N (-8 , -2)

N' (1 , 7)

O (,)

O' (,)

P (,)

P' (,)

Name: _____

Translation

Translate $\triangle DEF$ 3 units to the left and 7 units down.
Write the coordinates of $\triangle D'E'F'$.

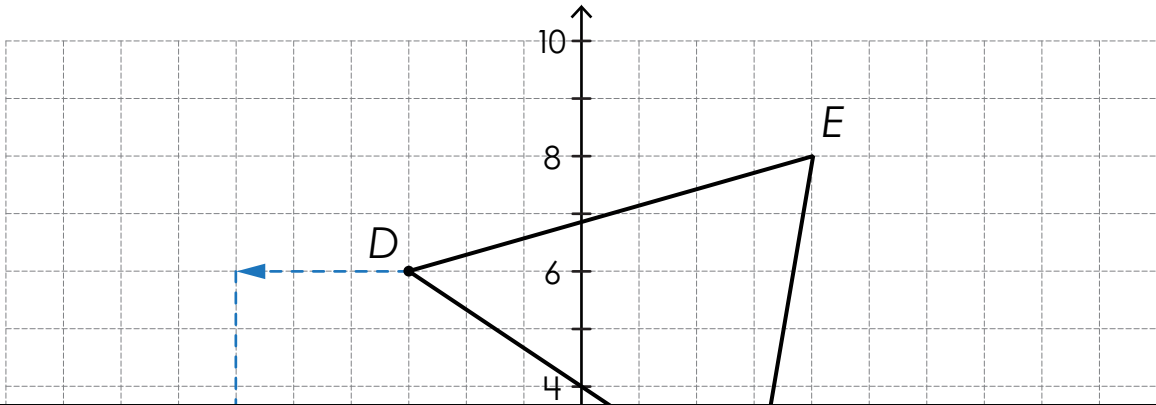

Preview

Please log in to download the printable version of this worksheet.

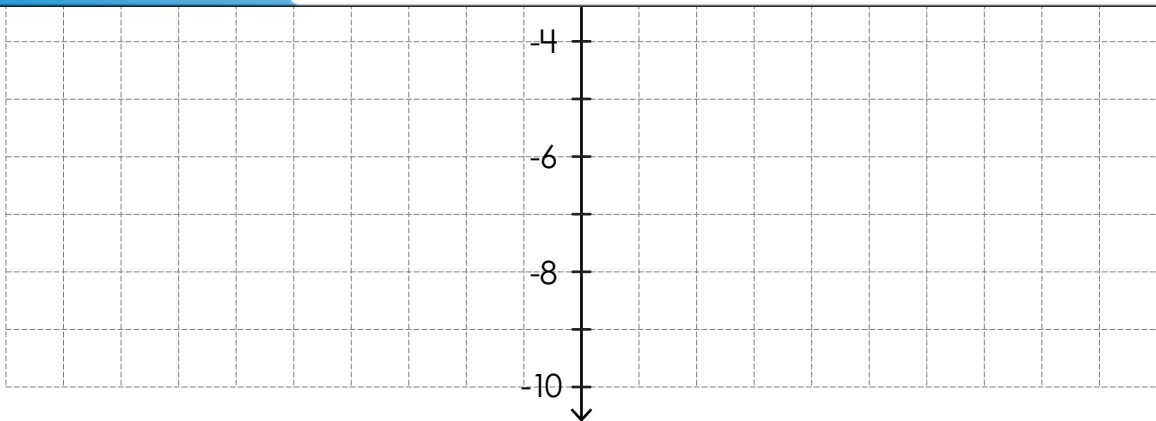

D (-3 , 6)

D' (-6 , -1)

E (,)

E' (,)

F (,)

F' (,)

Name: _____

Translation

Describe the translation of $\triangle RST$ to $\triangle R'S'T'$.

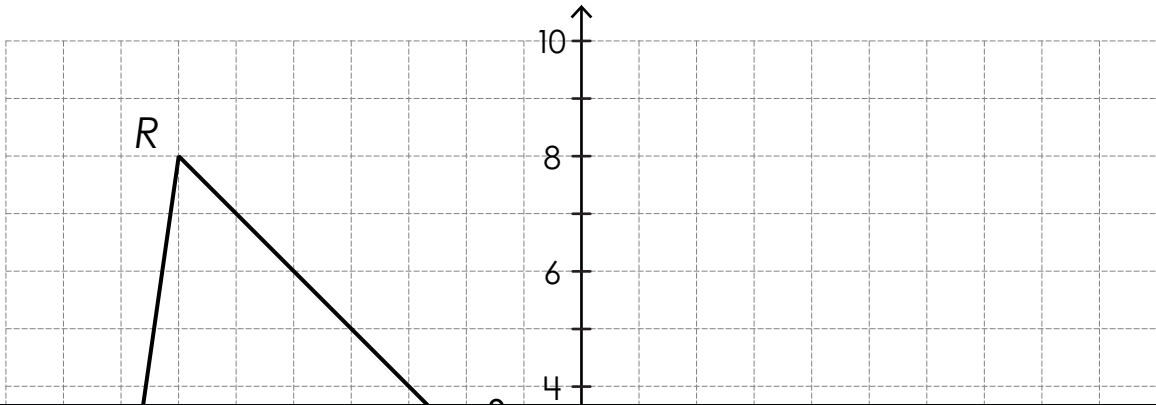

Preview

Please log in to download the printable version of this worksheet.

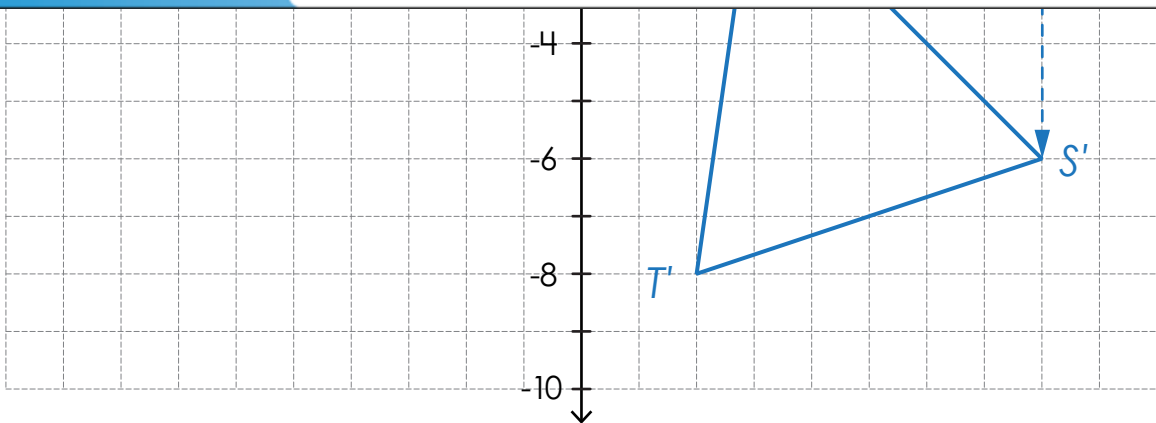

Fill in the blanks.

$\triangle RST$ was translated _____ units to the _____ and _____ units _____ .

ANSWER KEY

Translation

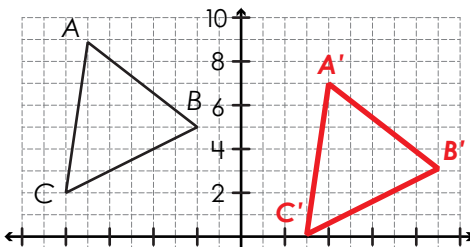

$\triangle ABC$

A (-7, 9)
B (-2, 5)
C (-8, 2)

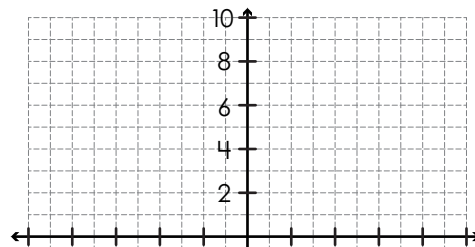

$\triangle EFG$

E (5, -2)
F (7, -7)
G (1, -6)

Preview

Please log in to download
the printable version of this worksheet.

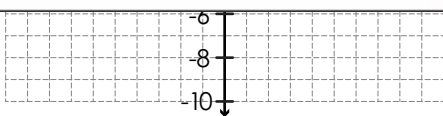

E' (1, 1)
F' (0, -5)

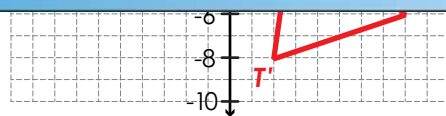

$\triangle RST$ was translated 10 units to the right
and 9 units down.